

Varenummer: 0101206  
 Beskrivelse: Seeger låsering A 340 DIN 471  
 Fjederstål  
 Note: Monteres med ZGA tang

## Mål

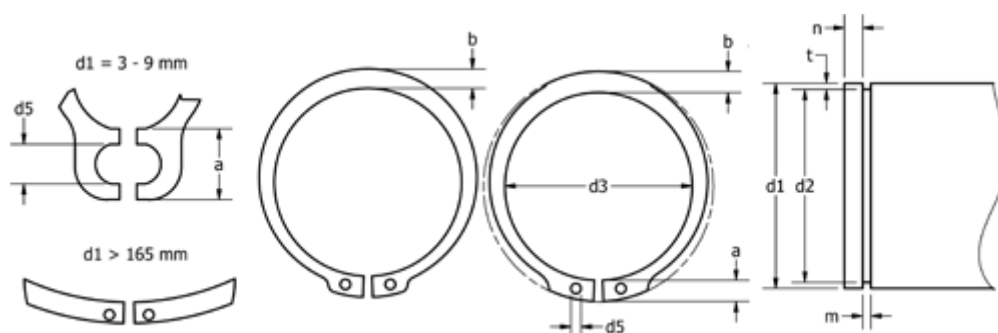

a max	= -	FN kN	= 876.0	s	= 6.00
AN mm <sup>2</sup>	= 5260.0	FRg kN	= 80.00	t	= 5.00
b	= 20.0	FR kN	= 932.00	Tang	= ZGA-6
Betegnelse	= A340	g	= 7.0	tol	= -0.15
d1	= 340	K kN-mm	= 2136.00	tol	= +0,90-2,00
d2	= 330.0	m min	= 6.20	tol	= -0.89
d3	= 323.0	n abl x 1000	= 1.0	vægt kg/1000	= 840.000
d5 min	= 6.0	Nominel træk	= 15.0		